

PRICE LIST 2011

VALID FROM 1ST APRIL 2011

Kroll[®]



HEATING
VENTILATING
DEHUMIDIFYING



Are you interested in our permanently
condensing boilers?

Power range from 15 to 250 kW,
and in cascade up to 2000 kW possible!



Ask for our permanently condensing
boiler/ solar price list!

Kroll Kirchberg
Sales
Fax

 **07144-830 200**
 **07144-830 201**

Stationary warm air heaters oil/gas	(S / H)	page	4
Mobile warm air heaters oil/gas	(SL / M / MK)	page	19
Mobile oil heaters	(MA / MAK / GK / GP)	page	28
Mobile heating plant oil/gas	(HM 200)	page	31
Mobile gas heaters	(P / PX / PE / W12)	page	32
Multi fuel oil burner / heater	(KG-UB / W 401)	page	36
Electric heaters	(E)	page	39
Air heaters	(LH)	page	40
Gas-warm air heaters, atmospheric	(N)	page	50
Gas-warm air heaters, atmospheric, duct version	(NK)	page	52
Fan / Dehumidifiers	(SV / T / TK)	page	58
Side channel compressor / water separator	(SKV / WAS)	page	60
Conditions of sales and delivery		page	61

This price list supersedes all previous price lists.



POWER RANGE 28 – 55 KW

- ▶ Stainless steel combustion chamber
- ▶ Stainless steel heat exchanger
- ▶ Radial fan
- ▶ Floor, wall and ceiling versions available
- ▶ Heating or ventilating control

MODEL

		25S	25S for duct version without outlet cover	40S	40S for duct version without outlet cover	55S	55S for duct version without outlet cover
	€	2.316,-	2.438,-	3.050,-	3.156,-	3.595,-	3.665,-
	No.	027700	025458	027701	025458	027702	025458
Rated heat load	kW	28	28	40	40	55	55
BTU's in 000's	BTU	95.6	95.6	136	136	187.8	187.8
Air rate	m³/h	1.650	1.650	2.900	2.900	3.700	3.700
External pressure	Pa	80	max. 300*	100	max. 300*	100	max. 300*
Electrical connection	V	230	230	230	230	230	230 400
Air outlet cover 3-sided with outlet grill ZG2 /		+		+		+	
Air inlet grill		+		+		+	

Horizontal construction on request.

* higher pressures on request.

ACCESSORIES

		25S	40S	55S
Oil burner	€	883,-	883,-	883,-
	No.	027485	027486	027487
LPG burner	€	1.341,-	1.520,-	1.520,-
	No.	005821	005822	005822
Natural gas burner	€	1.341,-	1.520,-	1.520,-
	No.	005813	005814	005815

ACCESSORIES		25S	40S	55S
Fixing components				
Floor standing unit frame	€	237,-	251,-	264,-
	No.	030501	030502	030503
Wall bracket for standing unit	€	198,-	198,-	255,-
	No.	030505	030506	030507
Wall bracket for horizontal unit	€	198,-	198,-	254,-
	No.	030509	030510	030511
Support for horizontal unit	€	173,-	173,-	187,-
	No.	030513	030514	030515
Burner air inlet				
Burner casing	€	334,-	334,-	334,-
	No.	030469	030469	030469
Inlet elbow 90°	€	50,-	50,-	50,-
	No.	021853	021853	021853
Inlet elbow 45°	€	40,-	40,-	40,-
	No.	011915	011915	011915
Inlet pipe 1 m long	€	50,-	50,-	50,-
	No.	021856	021856	021856
Inlet terminal with grill	€	50,-	50,-	50,-
	No.	021859	021859	021859
Duct-outlet accessories				
Duct-cap drawn round	€	289,-	289,-	289,-
	No.	030537	030538	030539

** additional accessories on request.



POWER RANGE 70 – 110 KW

- ▶ Stainless steel combustion chamber
- ▶ Stainless steel heat exchanger
- ▶ Radial fan
- ▶ Floor, wall and ceiling versions available
- ▶ Heating or ventilating control

MODEL

		70S	70S for duct ver- sion without outlet cover	95S	95S for duct ver- sion without outlet cover	110S	110S for duct ver- sion without outlet cover
	€	4.014,-	4.180,-	4.824,-	4.990,-	5.235,-	5.402,-
	No.	027703	025458	030821	025458	027704	025458
Rated heat load	kW	70	70	95	95	110	110
BTU's in 000's	BTU	239	239	324.4	324.4	375.6	375.6
Air rate	m³/h	5.000	5.000	6.750	6.750	7.650	7.650
External pressure	Pa	100	max. 300*	100	max. 300*	100	max. 300*
Electrical connection	V	230	230 400	400	400	400	400
Air outlet cover 3-sided with grill ZG2 /		+		+		+	
Air inlet grill		+		+		+	

Horizontal construction on request.

* higher pressures on request.

ACCESSORIES

		70S	95S	110S
Oil burner	€	915,-	915,-	915,-
	No.	005785	006224	006224
LPG burner	€	1.690,-	1.690,-	1.690,-
	No.	005824	005824	005824
Natural gas burner	€	1.887,-	1.887,-	1.887,-
	No.	005816	005816	005816

ACCESSORIES		70S	95S	110S
Fixing components				
Floor standing unit frame	€ No.	287,- 030504	287,- 034587	287,- 034587
Wall bracket for standing unit	€ No.	271,- 030508	273,- 034651	273,- 034651
Wall bracket for horizontal unit	€ No.	270,- 030512	367,- 034713	367,- 034713
Support for horizontal unit	€ No.	199,- 030516	199,- 034714	199,- 034714
Support for ceiling suspension	€ No.	199,- 030520	199,- 034715	199,- 034715
Burner air inlet				
Burner casing	€ No.	344,- 030473	334,- 030473	334,- 030473
Inlet elbow 90°	€ No.	50,- 021853	50,- 021853	50,- 021853
Inlet elbow 45°	€ No.	40,- 011915	40,- 011915	40,- 011915
Inlet pipe 1 m long	€ No.	50,- 021856	50,- 021856	50,- 021856
Inlet terminal with grill	€ No.	50,- 021859	50,- 021859	50,- 021859
Duct-outlet accessories				
Duct-cap drawnd round	€ No.	307,- 030540	315,- 034719	315,- 034719
Outlet head 3 - sided ZG2	€ No.	375,- 030548	387,- 034721	387,- 034721
Outlet head 1 - sided ZG2	€ No.	356,- 030552	421,- 034722	421,- 034722
Blind cover	€ No.	67,- 028035	69,- 028903	69,- 028903
Re-circulation grill	€ No.	49,- 030495	49,- 030497	49,- 030497
Transition mould piece	€ No.	151,- 021940	151,- 034723	151,- 034723
Pocket air cleaner	€ No.	800,- 021967	943,- 034726	943,- 034726
Set flat filter	€ No.	581,- 034197	587,- 034202	587,- 034202

** additional accessories on request.



POWER RANGE 129 – 194 KW

- ▶ Stainless steel combustion chamber
- ▶ Radial fan
- ▶ Oil or gas heating
- ▶ Heating or ventilating control
- ▶ Electrical connection 400 V

MODEL

		140S	140S or duct ver- sion without outlet cover	170S	170S or duct ver- sion without outlet cover	195S	195S for duct ver- sion without outlet cover
	€	5.694,-	5.449,-	5.927,-	5.997,-	7.696,-	7.817,-
	No.	021657	021699	021658	021711	021659	021716
Rated heat load	kW	129	129	163	163	194	194
BTU's in 000's	BTU	440.5	440.5	556.6	556.6	662.4	662.4
Air rate	m³/h	9.200	9.200	11.800	11.800	13.800	13.800
External pressure	Pa	90	max. 350*	100	max. 350*	90	max. 350*
Air outlet cover 3-sided with grill ZG2 /		+		+		+	
Air inlet grill		+		+		+	

Horizontal construction on request.

* higher pressures on request.

ACCESSORIES

		140S	170S	195S
Oil burner	€	915,-	1.529,-	1.529,-
	No.	006194	005811	006195
LPG burner	€	1.976,-	1.976,-	1.976,-
	No.	006009	006009	006009
Natural gas burner	€	2.581,-	2.584,-	2.581,-
	No.	006006	006006	006006
Additional charge for heat exchanger in stainless steel		on request	on request	on request
Additional charge for heat exchanger in stainless steel with condensate drain		on request	on request	on request

ACCESSORIES		140S	170S	195S
Fixing components				
Floor standing unit frame	€ No.	287,- 021833	287,- 021833	327,- 021834
Wall bracket for standing unit	€ No.	274,- 021842	274,- 021842	274,- 011903
Wall bracket for horizontal unit	€ No.	367,- 021840	367,- 021840	367,- 021841
Support for horizontal unit	€ No.	199,- 011906	199,- 011906	193,- 021846
Support for ceiling suspension	€ No.	213,- 011907	213,- 011907	219,- 021850
Burner air inlet				
Burner casing	€ No.	344,- 011910	344,- 011910	344,- 011911
Duct-outlet accessories				
Air outlet cover 3-sided ZG2	€ No.	635,- 011874	635,- 011874	685,- 011875
Duct-cap lengthwise / frontal	€ No.	402,- 021887	402,- 021887	471,- 011880
Duct-cap drawnd round	€ No.	461,- 011888	461,- 011888	558,- 021897
Pocket air cleaner	€ No.	1.003,- 021969	1.003,- 021969	1.085,- 021970
Set flat filter	€ No.	623,- 021977	623,- 021977	694,- 021978

** additional accessories on request.



POWER RANGE 250 – 326 KW

- ▶ Stainless steel combustion chamber
- ▶ Radial fan
- ▶ Oil or gas heating
- ▶ Heating or ventilating control
- ▶ Electrical connection 400 V

MODEL

		260S	260S for duct version without outlet cover	290S	290S for duct version without outlet cover	360S	360S for duct version without outlet cover
	€	8.272,-	8.365,-	9.537,-	9.493,-	9.917,-	9.693,-
	No.	021618	021720	021660	021725	021661	021730
Rated heat load	kW	250	250	280	280	326	326
BTU's in 000's	BTU	853.6	853.6	956	956	1.113	1.113
Air rate	m³/h	18.400	18.400	20.600	20.600	23.400	23.400
External pressure	Pa	100	max. 350*	80	max. 350*	110	max. 350*
Air outlet cover 3-sided with grill ZG2 /		+		+		+	
Air inlet grill		+		+		+	

Horizontal construction on request.

* higher pressures on request.

ACCESSORIES

		260S	290S	360S
Oil burner	€	1.529,-	2.034,-	2.034,-
	No.	005884	006196	006189
LPG burner	€	1.976,-	3.981,-	3.981,-
	No.	006009	021806	021806
Natural gas burner	€	2.581,-	4.605,-	4.605,-
	No.	021669	021793	021793
Additional charge for heat exchanger in Stainless steel		on request	on request	on request
Additional charge for heat exchanger in Stainless steel with condensate drain		on request	on request	on request

ACCESSORIES		260S	290S	360S
Fixing components				
Floor standing unit frame	€ No.	327,- 021834	544,- 021835	544,- 021835
Wall bracket for standing unit	€ No.	274,- 011903	287,- 021843	287,- 021843
Wall bracket for horizontal unit	€ No.	378,- 021841		
Support for horizontal unit	€ No.	193,- 021846	239,- 021847	239,- 021847
Support for ceiling suspension	€ No.	219,- 021850	269,- 021851	269,- 021851
Burner air inlet				
Burner casing	€ No.	333,- 011911	414,- 011912	414,- 011912
Duct-outlet accessories				
Air outlet cover 3-sided ZG2	€ No.	685,- 011875	1.082,- 011876	1.082,- 011876
Duct-cap lengthwise / frontal	€ No.	471,- 011880	675,- 021888	675,- 021888
Duct-cap drawnd round	€ No.	558,- 021897	582,- 021898	582,- 021898
Pocket air cleaner	€ No.	1.085,- 021970	1.160,- 021971	1.160,- 021971
Set flat filter	€ No.	694,- 021978		

** additional accessories on request.



POWER RANGE 423 – 544 KW

- ▶ Stainless steel combustion chamber
- ▶ Radial fan
- ▶ Oil or gas heating
- ▶ Heating or ventilating control
- ▶ Electrical connection 400 V

MODEL

		430S	430S for duct ver- sion without outlet cover	490S	490S for duct ver- sion without outlet cover	580S	580S for duct ver- sion without outlet cover
€ No.		13.119,- 021662	12.789,- 021735	13.616,- 021663	12.943,- 021740	17.675,- 021664	17.972,- 021745
Rated heat load	kW	423	423	489	489	544	544
BTU's in 000's	BTU	1.444	1.444	1.670	1.670	1.857	1.857
Air rate	m³/h	29.500	31.000	35.000	34.900	37.500	38.000
External pressure	Pa	100	max. 350*	120	max. 350*	100	max. 350*
Air outlet cover 3-sided with grill ZG2 /		+		+		+	
Air inlet grill		+		+		+	

Horizontal construction on request.

* higher pressures on request.

ACCESSORIES

		430S	490S	580S
Oil burner	€ No.	2.637,- 021788	2.637,- 021789	3.283,- 021790
LPG burner	€ No.	5.007,- 029326	5.007,- 029326	6.245,- 021810
Natural gas burner	€ No.	5.735,- 029199	5.735,- 029201	7.455,- 021798
Additional charge for heat exchanger in Stainless steel		on request	on request	on request
Additional charge for heat exchanger in Stainless steel with condensate drain		on request	on request	on request

ACCESSORIES		430S	490S	580S
Fixing components				
Floor standing unit frame	€ No.	549,- 022100	549,- 022100	552,- 021836
Wall bracket for standing unit	€ No.	287,- 022102	287,- 022102	409,- 021844
Support for horizontal unit	€ No.	267,- 022105	267,- 022105	317,- 021848
Support for ceiling suspension	€ No.	301,- 022107	301,- 022107	342,- 021852
Burner air inlet				
Burner casing	€ No.	414,- 011912	414,- 011912	414,- 011912
Duct-outlet accessories				
Air outlet cover 3-sided ZG2	€ No.	1.278,- 022109	1.278,- 022109	1.970,- 011878
Duct-cap lengthwise / frontal	€ No.	820,- 022111	853,- 022111	938,- 021889
Duct-cap drawnd round	€ No.	750,- 022113	750,- 022113	797,- 021899
Pocket air cleaner	€ No.	1.371,- 022127	1.371,- 022127	1.783,- 021972

** additional accessories on request.



POWER RANGE 598 – 652 KW

- ▶ Stainless steel combustion chamber
- ▶ Radial fan
- ▶ Oil or gas heating
- ▶ Heating or ventilating control
- ▶ Electrical connection 400 V

MODEL

		650S	650S for duct version without outlet cover	730S	730S for duct version without outlet cover
€ No.		19.122,- 021665	18.025,- 021750	19.457,- 021666	18.892,- 021755
Rated heat load	kW	598	598	652	652
BTU's in 000's	BTU	2.042	2.042	2.226	2.226
Air rate	m³/h	42.600	42.600	48.300	48.300
External pressure	Pa	120	max. 350*	140	max. 350*
Air outlet cover 3-sided with grill ZG2 /		+		+	
Air inlet grill		+		+	

Horizontal construction on request.

* higher pressures on request.

ACCESSORIES

		650S	730S
Oil burner	€ No.	3.283,- 021790	3.283,- 021792
LPG burner	€ No.	6.245,- 021810	6.245,- 021810
Natural gas burner	€ No.	7.455,- 021798	7.455,- 021798
Additional charge for heat exchanger in Stainless steel		on request	on request
Additional charge for heat exchanger in Stainless steel with condensate drain		on request	on request

ACCESSORIES		650S	730S
Fixing components			
Floor standing unit frame	€ No.	552,- 021836	552,- 021836
Wall bracket for standing unit	€ No.	409,- 021844	409,- 021844
Support for horizontal unit	€ No.	317,- 021848	317,- 021848
Burner air inlet			
Burner casing	€ No.	414,- 011912	414,- 011912
Duct-outlet accessories			
Air outlet cover 3-sided ZG2	€ No.	1.970,- 011878	1.970,- 011878
Duct-cap lengthwise / frontal	€ No.	938,- 021889	938,- 021889
Duct-cap drawnd round	€ No.	796,- 021899	796,- 021899
Pocket air cleaner	€ No.	1.783,- 021972	1.783,- 021972

** additional accessories on request.

ACCESSORIES

Electronic accessories and oil filter for 25S - 730S

Room thermostat RTI, Specification IP 54	€ No.	56,- 005434	56,- 005434
Oil filter with return	€ No.	59,- 005330	59,- 005330
Automatic filter oil aspirator with filter	€ No.	106,- 006903	106,- 006903
Day / Night control in plastic box with digital clock, power reserve, for night-time heating, day and week programming, including 1 room sensor	€ No.	384,- 006708	384,- 006708
Day / Night control in plastic box with digital clock, power reserve, for night-time heating, day and week programming, including 1 room sensor for 2 heaters with extra control box	€ No.	541,- 006847	541,- 006847
Operating hour meter	€ No.	105,- 006577	105,- 006577

Ceiling fan, also for Air Heater and all Warm Air Heaters

Ceiling fan	€ No.	199,- 006245	199,- 006245
Speed control, continuously variable, up to 5 Ceiling fans	€ No.	125,- 006735	125,- 006735
Control for 1 - 12 Ceiling fans, incl. speed control and 1 room sensor	€ No.	457,- 006900	457,- 006900
Control with day / night switching mechanism for 1 - 12 ceiling fans, incl. 2 room sensors, speed control and digital clock	€ No.	717,- 006901	717,- 006901
Differential temp. control for 1 - 12 Ceiling fans, incl. 2 room sensors	€ No.	260,- 006902	260,- 006902

** additional accessories on request.

Vertical version

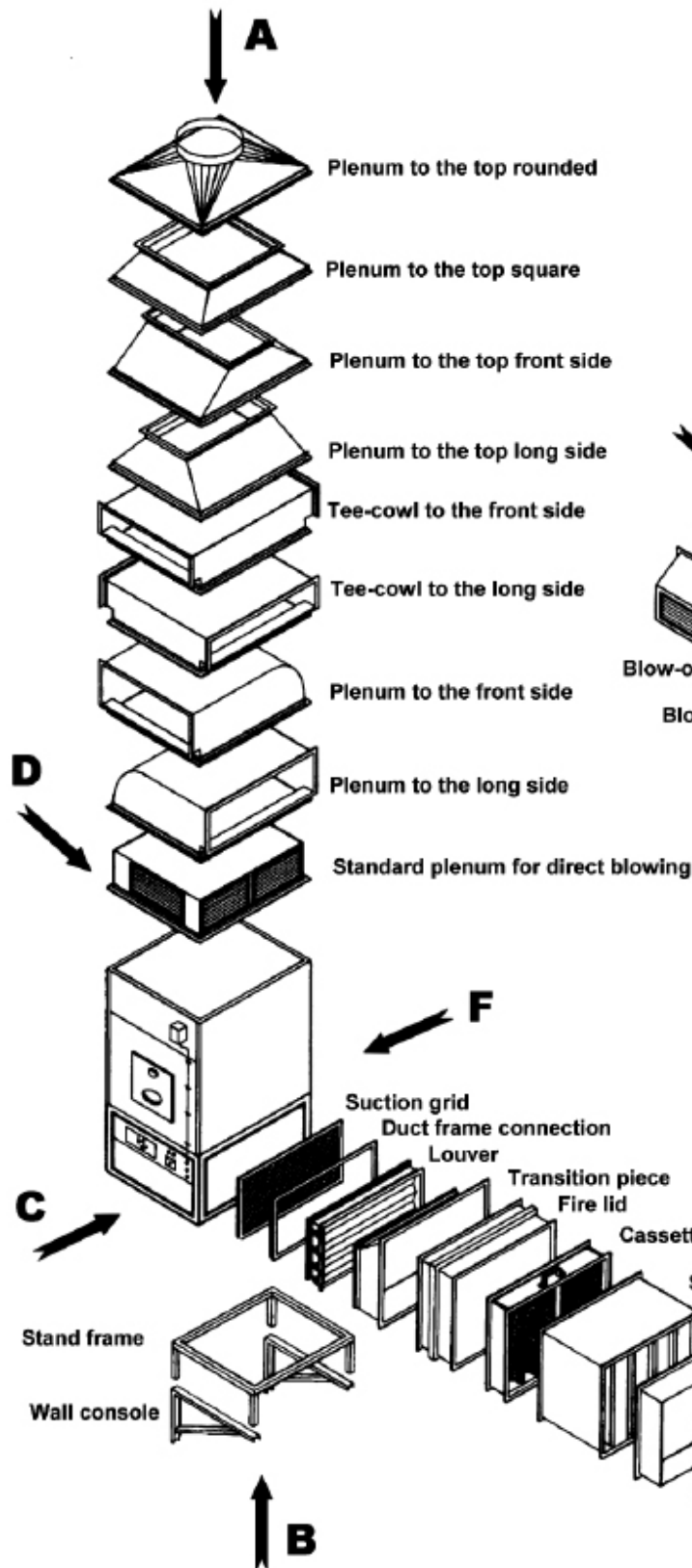

Horizontal version

lying on the left = LL
 lying on the right = LR
 (illustration = LL)

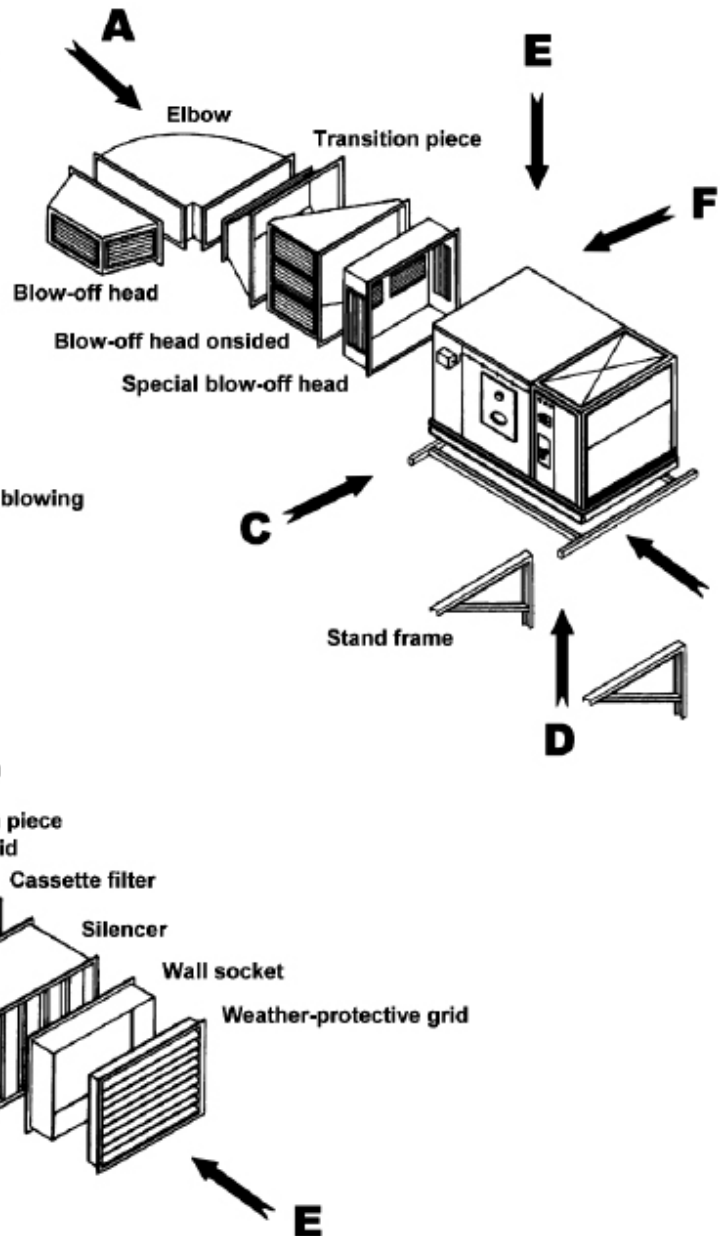



POWER RANGE 28 – 70 KW

- ▶ Stainless steel combustion chamber
- ▶ Stainless steel heat exchanger
- ▶ Fan axial
- ▶ Outlet grill ZG2
- ▶ Wall mounting
- ▶ Heating or ventilating control

MODEL

		25H	40H	55H	70H
	€	2.389,-	3.057,-	3.457,-	4.133,-
	No.	031764	031765	031766	033900
Rated heat load	kW	28	40	55	70
BTU's in 000's	BTU	95	137	187	239
Air rate	m³/h	2.050	2.900	4.900	5.500

ACCESSORIES

		25H	40H	55H	70H
Oil burner	€	883,-	883,-	883,-	915,-
	No.	027485	027486	027487	005785
LPG burner	€	1.341,-	1.520,-	1.520,-	1.690,-
	No.	005821	005822	005822	005824
Natural gas burner	€	1.341,-	1.520,-	1.520,-	1.887,-
	No.	005813	005814	005815	005816
Wall bracket	€	206,-	206,-	264,-	264,-
	No.	001112	001112	001155	001155

ElektroAccessories und Ölfilter

25H - 70H

Room thermostat RTI Specification, IP54	€	56,-
	No.	005434
Oil filter with return	€	59,-
	No.	005330
Automatic filter oil aspirator with filter	€	106,-
	No.	006903
Day / Night control in plastic box with digital clock, power reserve, for night-time heating, day and week programming, including 1 room sensor	€	384,-
	No.	006708
Day / Night control in plastic box with digital clock, power reserve, for night-time heating, day and week programming, including 1 room sensor for 2 heaters with extra control box	€	541,-
	No.	006847
Operating hour meter	€	105,-
	No.	006577

WARM AIR HEATERS



POWER RANGE 28 – 70 KW

- ▶ Stainless steel combustion chamber
- ▶ Stainless steel heat exchanger
- ▶ Room thermostat
- ▶ Axial fan
- ▶ Outlet Grill ZG2
- ▶ Oil burner
- ▶ Storage tank
- ▶ Oil filter

MODEL		25SL	40SL	55SL	70SL
	€ No.	3.444,- 034041	4.193,- 034042	4.412,- 034043	5.257,- 034044
Rated heat load	kW	28	40	55	70
	BTU's in 000's	96	137	188	239
Air rate	m ³ /h	2.050	2.900	4.900	5.500
Storage tank	litre	47	57	77	97



POWER RANGE 25 – 51 KW

- ▶ Stainless steel combustion chamber
- ▶ Stainless steel heat exchanger
- ▶ Tank with heating element
- ▶ Axial or radial fan
- ▶ Recirculated-air operation possible
- ▶ Room thermostat can be connected optionally
- ▶ Nozzle fitting heated
- ▶ Also certified for gas

MODEL

With oil burner		M 25	M 25 R	M 50
	€	3.040,-	3.280,-	4.110,-
	No.	000291	040720	000296
With natural gas burner			M 25 R N	M 50 N
	€		3.650,-	4.730,-
	No.		050600	050602
With LPG burner			M 25 R F	M 50 F
	€		3.650,-	4.580,-
	No.		050601	050603
Recirculated-air module for units with oil burner (available from 09/2011)	€		210,-	250,-
	No.		050620	050621
Recirculated-air module for units with gas burner (available from 09/2011)	€		290,-	340,-
	No.		050720	050721
Rated heat load	kW	25	25	51
BTU's in 000's	BTU	85	85	174
Air rate	m³/h	1.150	1.350	2.600
External pressure	Pa	80	150	170
Tank capacity	litre	27	27	46
Heaters with gas burner do not have a tank!				
Axial fan		+		
Radial fan			+	+



Examples of warm air hose connections.

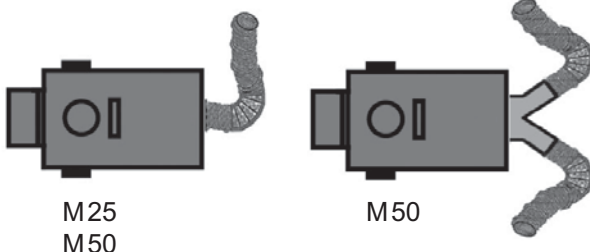

ACCESSORIES		M 25	M 50
		M 25 R / N / F	M 50 N / F
Room thermostat IP 54, 10 m cable, included plug	€ No.	133,- 000729	133,- 000729
Transition piece for 1 warm air hose	€ No.	Ø 305 mm 51,- 002313	Ø 405 mm 87,- 002419
Distributor for 2 warm air hoses Ø 305 mm	€ No.		278,- 012566
Warm air hose 7,6 m Ø 305 mm	€ No.	280,- 005417	280,- 005417
Warm air hose 7,6 m Ø 405 mm	€ No.		369,- 005418
Perforated air hose	€ No.	Ø 305 mm 18,- /m 006178	Ø 405 mm 20,- /m 006179
Warm air hose 3 m Ø 305 mm - 40°C to +175°C	€ No.	398,- 045720	
Warm air hose 3 m Ø 425 mm - 40°C to +175°C	€ No.		473,- 045721
Combined - Warm air hose 7,6 m Ø 305 mm consists of: 1 x hose 3 m / - 40°C to +175°C 1 x hose 4,6 m / - 20°C to +100°C	€ No.	560,- 045723	
Combined - Warm air hose 7,6 m Ø 425 mm consists of: 1 x hose 3 m / - 40°C to +175°C 1 x hose 4,6 m / - 20°C to +100°C	€ No.		700,- 045724
Connection piece Ø 305 mm for warm air hose	€ No.	32,- 002873	32,- 002873
Connection piece Ø 405 mm for warm air hose	€ No.		57,- 002909
Barrel brace with 3 m hose mix cup and return valve	€ No.	** 000867	** 000867
Flexible exhaust pipe 3 m stainless steel	€ No.	Ø 100 mm 198,- 006305	Ø 130 mm 259,- 006306
Flue pipe 1 m steel plate hot dip aluminium 0,6 mm	€ No.	18,- 012473	20,- 012474
Flue pipe elbow 90°	€ No.	15,- 012488	22,- 012489
Flue pipe rain cap	€ No.	32,- 012503	35,- 012504

** Price and delivery time on request.



POWER RANGE 71 – 100 KW

- ▶ Stainless steel combustion chamber
- ▶ Stainless steel heat exchanger
- ▶ Tank with heating element
- ▶ Radial fan
- ▶ Recirculated-air operation possible
- ▶ Room thermostat can be connected optionally
- ▶ Heated oil filter with single-line barrel brace
- ▶ Automatic heating oil-deventilation device
- ▶ Also certified for gas

MODEL

With oil burner		M 70	M 100
	€	4.950,-	5.940,-
	No.	000301	000282
With natural gas burner		M 70 N	M 100 N
	€	5.700,-	6.700,-
	No.	050604	050606
With LPG burner		M 70 F	M 100 F
	€	5.600,-	6.600,-
	No.	050605	050607
Tank for M 70 with 74 litres Already mounted! (available from 09/2011)	€	225,-	
	No.	000781	
Recirculated-air module for units with oil burner (available from 09/2011)	€	290,-	360,-
	No.	050622	050623
Recirculated-air module for units with gas burner (available from 09/2011)	€	380,-	450,-
	No.	050722	050723
Rated heat load	kW	71	100
BTU's in 000's	BTU	242	341
Air rate	m³/h	4.740	5.400
External pressure	Pa	180	150

NEW

NEW

NEW

NEW

NEW

Examples of warm air hose connections.



M 70
M 100

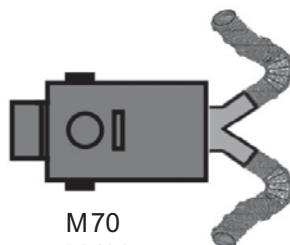

M 70
M 100

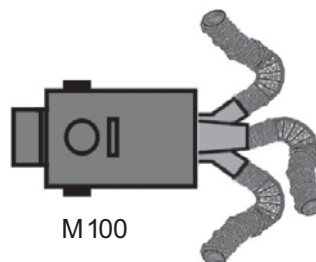

M 100

ACCESSORIES		M 70 M 70 N / F	M 100 M 100 N / F
Room thermostat IP 54, 10 m cable, included plug	€ No.	133,- 000729	133,- 000729
Transition piece for 1 warm air hose	€ No.	Ø 405 mm 114,- 012575	Ø 535 mm 136,- 012527
Distributor for 2 warm air hoses Ø 305 mm	€ No.	309,- 012576	318,- 012528
Distributor for 3 warm air hoses Ø 305 mm	€ No.		338,- 012529
Warm air hose 7,6 m Ø 305 mm	€ No.	280,- 005417	280,- 005417
Warm air hose 7,6 m Ø 405 mm	€ No.	369,- 005418	
Warm air hose 7,6 m Ø 535 mm	€ No.		452,- 005597
Perforated air hose	€ No.	Ø 405 mm 20,- /m 006179	Ø 535 mm 22,- /m 006180
Warm air hose 3 m Ø 305 mm - 40°C to +175°C	€ No.		398,- 045720
Warm air hose 3 m Ø 425 mm - 40°C to +175°C	€ No.	473,- 045721	
Warm air hose 3 m Ø 525 mm - 40°C to +175°C	€ No.		592,- 045722
Combined - Warm air hose 7,6 m Ø 305 mm consists of: 1 x hose 3 m / - 40°C to +175°C 1 x hose 4,6 m / - 20°C to +100°C	€ No.		560,- 045723
Combined - Warm air hose 7,6 m Ø 425 mm consists of: 1 x hose 3 m / - 40°C to +175°C 1 x hose 4,6 m / - 20°C to +100°C	€ No.	700,- 045724	
Combined - Warm air hose 7,6 m Ø 525mm consists of: 1 x hose 3 m / - 40°C to +175°C 1 x hose 4,6 m / - 20°C to +100°C	€ No.		839,- 045725
Connection piece Ø 305 mm for Warm air hose	€ No.	32,- 002873	32,- 002873
Connection piece Ø 405 mm for warm air hose	€ No.	57,- 002909	
Connection piece Ø 535 mm for Warm air hose	€ No.		63,- 002800
Flexible exhaust pipe 3 m stainless steel	€ No.	355,- 006307	355,- 006307
Flue pipe 1 m steel plate hot dip aluminium 0,6 mm	€ No.	42,- 012477	42,- 012477
Flue pipe elbow 90°	€ No.	49,- 012492	49,- 012492
Flue pipe rain cap	€ No.	63,- 012507	63,- 012507



POWER RANGE 140 – 188 KW

- ▶ Stainless steel combustion chamber
- ▶ Stainless steel heat exchanger
- ▶ Tank with heating element
- ▶ Radial fan
- ▶ Recirculated-air operation possible
- ▶ Room thermostat can be connected optionally
- ▶ Heated oil filter with single-line barrel brace
- ▶ Automatic heating oil-deventilation device
- ▶ Also certified for gas

MODEL

With oil burner		M 150	M 200
	€	6.800,-	7.500,-
	No.	000284	000287
With natural gas burner		M 150 N	M 200 N
	€	7.900,-	8.350,-
	No.	050608	050610
With LPG burner		M 150 F	M 200 F
	€	7.750,-	8.150,-
	No.	050609	050611
Recirculated-air module for units with oil burner (available from 09/2011)	€	430,-	460,-
	No.	050624	050625
Recirculated-air module for units with gas burner (available from 09/2011)	€	520,-	580,-
	No.	050724	050725
Rated heat load	kW	140	188
BTU's in 000's	BTU	470	642
Air rate	m ³ /h	7.300	10.200
External pressure	Pa	150	150

NEW

NEW

NEW

NEW

Examples of warm air hose connections.



M 150
M 200

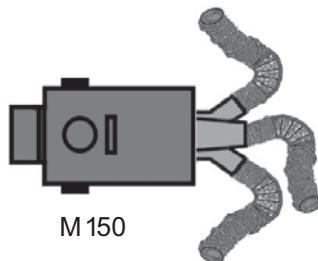

M 150

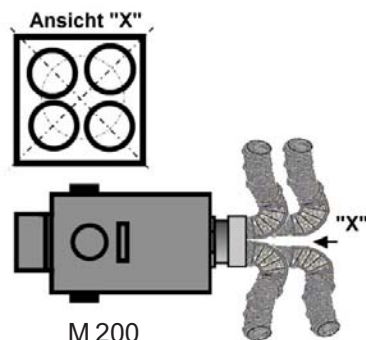

M 200

ACCESSORIES	M 150		M 200	
		M 150 N / F		M 200 N / F
Room thermostat IP 54, 10 m cable, included plug	€ No.	133,- 000729		133,- 000729
Transition piece for 1 warm air hose	€ No.	136,- 012527		136,- 012527
Distributor for 3 warm air hoses Ø 305 mm	€ No.	338,- 012529		
Distributor for 4 warm air hoses Ø 305 mm	€ No.			398,- 012530
Warm air hose 7,6 m Ø 305 mm	€ No.	280,- 005417		280,- 005417
Warm air hose 7,6 m Ø 535 mm	€ No.	452,- 005597		452,- 005597
Warm air hose 7,6 m Ø 560 mm	€ No.			486,- 026991
Perforated air hose	€ No.	Ø 535 mm 22,- /m 006180		Ø 535 mm 22,- /m 006180
Warm air hose 3 m Ø 305 mm - 40°C to +175°C	€ No.	398,- 045720		398,- 045720
Warm air hose 3 m Ø 525 mm - 40°C to +175°C	€ No.	592,- 045722		592,- 045722
Warm air hose 3 m Ø 560 mm - 40°C to +175°C	€ No.			545,- 050701
Combined - Warm air hose 7,6 m Ø 305 mm consists of: 1 x hose 3 m / - 40°C to +175°C 1 x hose 4,6 m / - 20°C to +100°C	€ No.	560,- 045723		560,- 045723
Combined - Warm air hose 7,6 m Ø 525mm consists of: 1 x hose 3 m / - 40°C to +175°C 1 x hose 4,6 m / - 20°C to +100°C	€ No.	839,- 045725		839,- 045725
Combined - Warm air hose 7,6 m Ø 560mm consists of: 1 x hose 3 m / - 40°C to +175°C 1 x hose 4,6 m / - 20°C to +100°C	€ No.			788,- 050699
Connection piece Ø 305 mm for warm air hose	€ No.	32,- 002873		32,- 002873
Connection piece Ø 535 mm for warm air hose	€ No.	63,- 002800		63,- 002800
Connection piece Ø 560 mm for warm air hose	€ No.			74,- 026985
Flexible exhaust pipe 3 m stainless steel	€ No.	355,- 006307		355,- 006307
Flue pipe 1 m steel plate hot dip aluminium 0,6 mm	€ No.	42,- 012477		42,- 012477
Flue pipe elbow 90°	€ No.	49,- 012492		49,- 012492
Flue pipe rain cap	€ No.	63,- 012507		63,- 012507



POWER RANGE 28 – 150 KW

- ▶ Stainless steel combustion chamber
- ▶ Stainless steel heat exchanger
- ▶ Axial fan
- ▶ Heated oil filter with single-line barrel brace
- ▶ Room thermostat can be connected optionally
- ▶ Automatic heating oil-deventilation device

MODEL

		M 25 K	M 50 K	M 70 K
	€	2.778,-	3.647,-	4.918,-
	No.	026767	026768	026150
Rated heat load	kW	28	50	70
BTU's in 000's	BTU	95	171	239
Air rate	m³/h	1.790	2.900	4.540
zzle fitting heated		+	+	

Examples of warm air hose connections.

** maximum length of hoses: 7,6 m per hose!

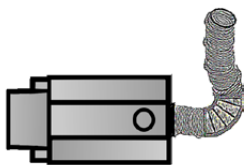

M25K
M50K
M70K

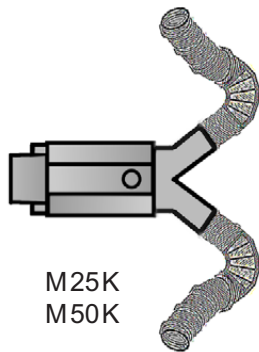

M25K
M50K

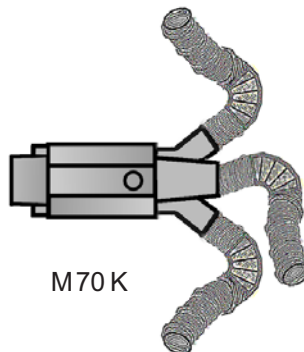

M70K

ACCESSORIES

		M 25 K	M 50 K	M 70 K
Room thermostat IP 54, 10 m cable, included plug	€ No.	133,- 000729	133,- 000729	133,- 000729
Distributor for 2 warm air hoses Ø 305 mm	€ No.	289,- 030478	289,- 030479	
Distributor for 3 warm air hoses Ø 305 mm	€ No.			355,- 030480
Warm air hose 7,6 m Ø 305 mm	€ No.	280,- 005417	280,- 005417	280,- 005417
Warm air hose 7,6 m Ø 405 mm	€ No.		369,- 005418	369,- 005418
Perforated air hose	€ No.	Ø 305 mm 18,- /m 006178	Ø 405 mm 20,- /m 006179	Ø 405 mm 20,- /m 006179
Barrel brace with 3 m hose mix cup and return valve	€ No.	127,- 026397	127,- 026397	127,- 026397
Flexible exhaust pipe 3 m stainless steel	€ No.	Ø 130 mm 259,- 006306	Ø 130 mm 259,- 006306	Ø 180 mm 355,- 006307
Flue pipe 1 m steel plate hot dip aluminium 0,6 mm	€ No.	20,- 012474	20,- 012474	42,- 012477
Flue pipe elbow 90°	€ No.	22,- 012489	22,- 012489	49,- 012492
Flue pipe rain cap	€ No.	35,- 012504	35,- 012504	63,- 012507



Model MAK

POWER RANGE 15 – 84 KW

- ▶ Stainless steel combustion chamber
- ▶ Axial fan
- ▶ Room thermostat connection



Model MA

MODEL		MAK 15	MAK 25	MAK 40	MA 37	MA 55	MA 85
€	No.	1.383,- 042391	1.611,- 026816	1.770,- 036970	2.408,- 030857	2.682,- 030858	3.062,- 030859
Rated heat load	kW	15	26	38	36	52	84
BTU's in 000's	BTU	91	89	130	123	178	289
Air rate	m ³ /h	350	800	1.200	2.000	2.500	4.500
Exhaust pipe Ø 150 mm (MAK 25 Ø 140mm)		30	46	46	51	51	100
Compressor		+	+	+	+	+	+
High pressure pump		+	+	+			
Heated oil filter					+	+	+

ACCESSORIES		MAK 15	MAK 25	MAK 40	MA 37	MA 55	MA 85
Room thermostat IP 54, 10 m cable, included plug	€ No.	133,- 000729	133,- 000729	133,- 000729	133,- 000729	133,- 000729	133,- 000729
Flexible exhaust 3 m, stainless steel, Ø 150 mm (MAK 25 Ø 140 mm)	€ No.	283,- 006260	283,- 006260	289,- 031267	289,- 031267	289,- 031267	289,- 031267
Flue pipe 1 m, Ø 150 mm, sheet steel hot dip aluminium (MAK 25 Ø 140 mm)	€ No.	21,- 012475	21,- 012475	26,- 012476	26,- 012476	26,- 012476	26,- 012476
Flue pipe elbow 90°, Ø 150 mm (MAK 25 Ø 140 mm)	€ No.	32,- 012490	32,- 012490	32,- 012491	32,- 012491	32,- 012491	32,- 012491
Flue pipe T-piece 90°, Ø 150 mm (MAK 25 Ø 140 mm)	€ No.	63,- 012500	63,- 012500	71,- 012501	71,- 012501	71,- 012501	71,- 012501
Flue pipe rain cap, Ø 150 mm (MAK 25 Ø 140 mm)	€ No.	42,- 012505	42,- 012505	45,- 012506	45,- 012506	45,- 012506	45,- 012506
Connection piece for warm air hose, Ø 305 mm	€ No.				188,- 031904	188,- 031904	
Connection piece for warm air hose, Ø 450 mm	€ No.						191,- 031903
Warm air hose 7,6 m long, Ø 305 mm	€ No.				280,- 005417	280,- 005417	
Warm air hose 7,6 m long, Ø 450 mm	€ No.						376,- 031902



POWER RANGE 23 – 115 KW

- ▶ Stainless steel combustion chamber
- ▶ Axial fan
- ▶ Silent and powerful fan

MODEL		GK20	GK28	GK40	GK60	GP67	GP115
	€ No.	948,- 000163	956,- 000169	1.354,- 000172	1.626,- 036971	2.087,- 030860	2.773,- 030861
Rated heat load	kW	23	28	43	61	66	115
BTU's in 000's	BTU	79	96	147	208	225	393
Air rate	m³/h	400	500	1.050	2.800	2.800	4.800
Heated oil filter						+	+
Compressor		+	+	+	+		
High pressure pump						+	+
Room thermostat connection						+	+

ACCESSORIES

Room thermostat IP 54, 10 m cable, included plug	€ No.	133,- 000729
---	-------	-----------------

MOBILE HEATING PLANT

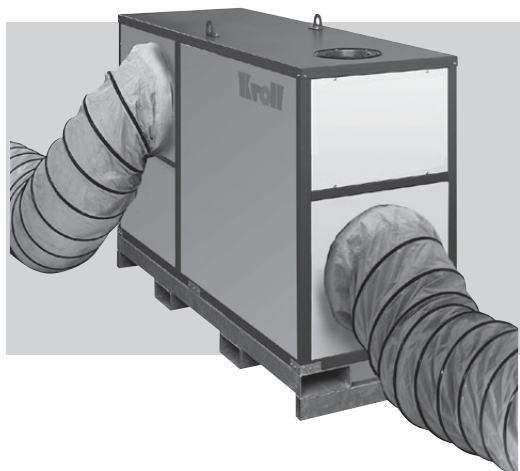

POWER RANGE 188 KW

- ▶ Stainless steel combustion chamber
- ▶ Stainless steel heat exchanger
- ▶ Radial fan
- ▶ Room thermostat can be connected optionally
- ▶ Heated oil filter with single-line barrel brace
- ▶ Automatic heating oil-deventilation device



MODEL		HM 200	HM 200 F	HM 200 N	HM 200/2 2-stage	HM 200/2 F 2-stage	HM 200/2 N 2-stage
		€	10.416,-	10.903,-	11.209,-	12.200,-	13.300,-
No.	000080	042039	042040	049333	050613	050612	
		Oil	Liquid gas	Natural gas	Oil	Liquid gas	Natural gas
Rated heat load	kW	188	188	188	133 / 188	133 / 188	133 / 188
	BTU's in 000's	642	642	642	452 / 642	452 / 642	452 / 642
Air rate	m ³ /h	10.500	10.500	10.500	7.600- 10.500	7.600- 10.500	7.600- 10.500
External pressure	Pa	350	350	350	175 / 350	175 / 350	175 / 350
Barrel brace		+			+		
Heated oil filter		+			+		

ACCESSORIES

		HM 200 / HM 200 2-stage / N / F	
Room thermostat IP 54	€		133,-
10 m cable, included plug	No.		000729
Warm air hose	€		486,-
7,6 m Ø 560 mm	No.		026991
Warm air hose 3m Ø 560 mm	€		545,-
-40 °C to +175°C	No.		050701
Combined warm air hose 7,6m Ø 560 mm	€		788,-
consists of:	No.		050699
1 hose 3m / -40°C to +175°C			
1 hose 4,6m / -20°C to +100°C			
Connection piece for Ø 560 mm	€		74,-
warm air hose	No.		026985
Transition piece for 1 warm air hose	€		136,-
	No.		012527
Warm air hose 7,6 m Ø 535 mm	€		452,-
	No.		005597
Connection piece for Ø 535 mm	€		61,-
warm air hose	No.		002800
Distributor for	€		398,-
4 warm air hoses Ø 305 mm	No.		012530



POWER RANGE 12 – 82 KW

- ▶ Powder-coated steel housing
- ▶ Piezo ignition
- ▶ Silent yet powerful fan
- ▶ Compact construction



MODEL		P10	P15	P30	P43	P60	P80	P100
	€ No.	281,- 027797	293,- 027796	421,- 000209	541,- 000226	743,- 000238	909,- 030460	1.346,- 042395
Rated heat load	kW	10	15	12,4- 31,0	26,6- 43,0	35,0- 58,0	50- 82,1	32,6- 96,5
BTU's in 000's	BTU	34	51	42-105	91-147	120-198	171-280	111-324
Air rate	m³/h	300	300	750	850	1.800	2.450	3300
Liquid gas		+	+	+	+	+	+	+
Piezo ignition		+	+	+	+	+	+	+
Connection brace with tube		+	+	+	+	+	+	+

ACCESSORIES		P30 - P100	
Gas bottle equipment	€ No.		64,- 005346



POWER RANGE 12 – 82 KW

- ▶ Silent yet powerful fan
- ▶ Electronic ignition
- ▶ Stainless steel housing (except PX60)
- ▶ Room thermostat can be connected optionally
- ▶ Compact construction

MODEL		PX30VA	PX43VA	PX60VA	PX80VA
	€ No.	710,- 000212	909,- 000223	1.010,- 050712	1.279,- 030462
Rated heat load	kW	12,4-31,0	26,6-43,0	35,0-58,0	50-82,1
BTU's in 000's	BTU	42 - 106	91 - 147	120 - 198	171 - 280
Air rate	m ³ /h	750	850	1.800	2.450
Liquid gas		+	+	+	+
Electronic ignition		+	+	+	+
Connection brace with tube		+	+	+	+
Cabinet stainless steel		+	+	+	+

ACCESSORIES

PX30VA - PX80VA

Room thermostat	€	133,-
IP 54, 10 m cable, included plug	No.	000729
Gas bottle equipment	€	64,-
	No.	005346

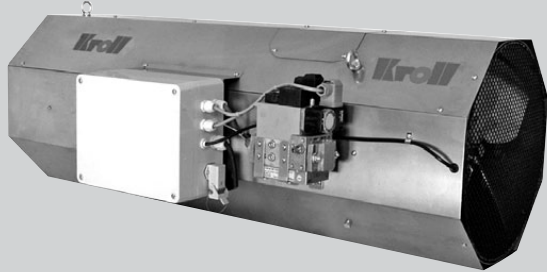

POWER RANGE 10 – 100 KW

- ▶ Stainless steel housing
- ▶ Electronic ignition
- ▶ For natural and liquid gas
- ▶ For ceiling mounting

MODEL		PE10	PE30	PE50	PE80	PE100
	€ No.	1.397,- 030883	1.544,- 030884	1.927,- 030885	2.217,- 030886	2.363,- 030887
Rated heat load	kW	10	30	50	80	100
BTU's in 000's	BTU	34	102	171	273	341
Air rate	m³/h	500	1.600	2.300	4.100	7.500
Natural gas		+	+	+	+	+
Liquid gas			+	+	+	+
Gas brace block		+	+	+	+	+

ACCESSORIES		PE10 - PE100
Room thermostat IP 54, 10 m cable, included plug	€ No.	133,- 038332
Bottle equipment	€ No.	64,- 005346

PATIO HEATER



HEATING POWER 12,5 KW

- ▶ Gas safety valve
- ▶ Hose protection
- ▶ Approved for professional use
- ▶ Ø 95 cm Aluminium shield

MODEL

		W 12 VA
		€ No.
		511,- S00121
Heating power	kW	12,5
BTU's in 000's	BTU	43
Connection armature		+
Housing stainless steel		+
Shield aluminium Ø 95 cm		+



POWER RANGE 14 – 54 KW

- ▶ Approval for rapeseed oil / TUV certified
- ▶ For mineral, vegetable and animal oils

MODEL

		KG / UB 20 PK	KG / UB 20	KG / UB 55
	€ No.	2.071,- 042510	2.071,- 027142	2.688,- 027143
Heating power with rape seed oil	kW	14-24	26-38	37-54
BTU's in 000's	BTU	48-82	89-130	126-184
Oil consumption approx	kg/h	1,4-2,3	2,5-3,9	3,6-5,2

ACCESSORIES

Feed system for external supply tank, feed pump with heated filter and	€ No.	895,- 000901	
Feed system with unit tank, feed pump, heated filter and floating suction pipe Tank capacity	€ No. litre	1.113,- 000900 59	
UBK 1 Compressor for KG/UB 20-P - 100	€ No.	1.129,- 030794	
Spacer with gasket necessary with certain types of boilers when using KG/UB 20-100	€ No.	66,- 034129	
ZVP-tube and fibre mat for KG/UB 20 only when used with warm air heaters 25 S and 40 S	€ No.	184,- 038768	
ZVP tube and ceramic fibre mat	€ No.	184,- 038672	
Ceramic fibre mat 6 mm, width 610 mm	€ No.	11,- 034241	lfd.m
Ceramic fibre plate ca. 25 x 500 x 500 mm	€ No.	96,- 039363	

MULTI FUEL OIL BURNER

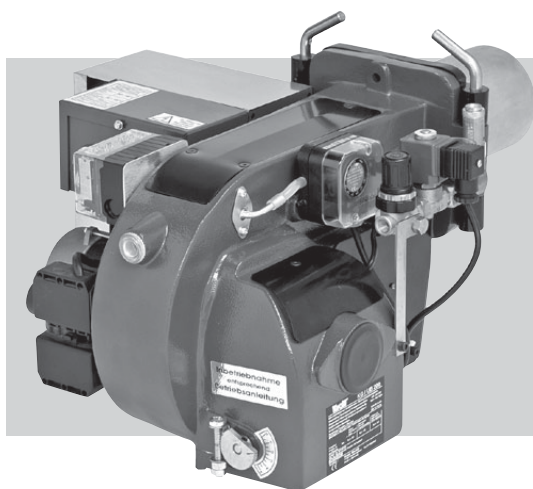

POWER RANGE 56 – 187 KW

- ▶ Approval for rapeseed oil / TUV certified
- ▶ For mineral, vegetable and animal oils

MODEL

		KG / UB 70	KG / UB 100	KG / UB 150	KG / UB 200
	€	2.780,-	2.780,-	3.615,-	3.615,-
	No.	027144	027145	027146	027147
Heating power with rape seed oil	kW	56-81	81-100	93-147	131-187
BTU's in 000's	BTU	191-277	277-341	318-502	447-638
Oil consumption approx	kg/h	5,4-7,8	7,8-9,6	8,9-14,1	12,7-18,0

ACCESSORIES

		KG / UB 70	KG / UB 100	KG / UB 150	KG / UB 200
Feed system for external supply tank, feed pump with heated filter and floating suction pipe	€ No.	895,- 000901	895,- 000901	895,- 000901	895,- 000901
Feed system for external supply tank, feed pump with non-heated filter and floating suction pipe	€ No.	619,- 047550	619,- 047550	619,- 047550	619,- 047550
Feed system with unit tank, feed pump, heated filter and floating suction pipe	€ No.	1.113,- 000900	1.192,- 000891	1.192,- 000891	1.192,- 000891
Tank capacity	litre	59	109	109	109
UBK 1 Compressor for KG/UB 20-P - 100	€ No.	1.129,- 030794	1.129,- 030794		
UBK 2 Compressor for KG/UB 150 - 200	€ No.			1.723,- 033184	1.723,- 033184
Spacer disk required for some boiler types	€ No.	66,- 034129	66,- 034129	66,- 034131	66,- 034131
ZVP tube and ceramic fibre mat	€ No.	242,- 038770	242,- 038770	285,- 038771	285,- 038771
Ceramic fibre mat 6 mm, width 610 mm	€ No. lfd.m	11,- 034241	11,- 034241	11,- 034241	11,- 034241
Ceramic fibre plate ca. 25 x 500 x 500 mm	€ No.	96,- 039363	96,- 039363	96,- 039363	96,- 039363



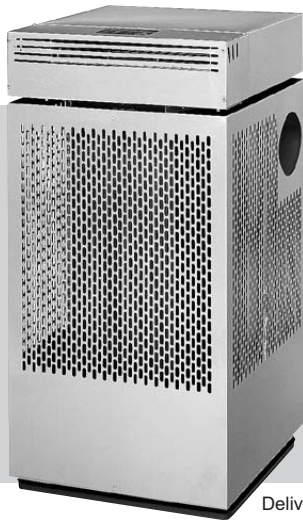

POWER RANGE 35 KW

- ▶ Complete with burner basin and oil tank
- ▶ Overflow protection

Delivered unit may differ from picture.

MODEL

		W401-L	W401-K
	€ No.	1.801,- 000059	2.385,- 046888
Heating power	kW	35	35
BTU's in 000's	BTU	120	120
Air rate	m ³ /h	120	580
Without fan		+	
With fan			+

ACCESSORIES

		W401-L	W401-K
Fan V 470	€ No.	583,- 000062	
Cleaning fluid	€ No.	57,- 000721	57,- 000721
Spare burner dish	€ No.	64,- 011639	64,- 011639
Floating switch for oil feed system	€ No.	295,- 047500	295,- 047500
Oil feed system (only together with item no. 047500)	€ No.	619,- 047550	619,- 047550
Feed system for external supply tank, feed pump with heated filter and	€ No.	895,- 000901	895,- 000901



POWER RANGE 3 – 18 KW

- ▶ For heating and ventilation
- ▶ Controlled by thermostat
- ▶ Robust construction



MODEL		E 3	E 8	E 12	E 18	E 18 S *
	€ No.	385,- 000138	885,- 000143	1.205,- 000147	1.535,- 000153	1.690,- 050618
Heating power	kW	3	4 / 8	6 / 12	12 / 18	12 / 18
BTU's in 000's	BTU	10	14 - 27	20 - 41	41 - 61	41 - 61
Air rate	m³/h	185	420	735	960	960
Connection		Schuko- stecker	CEE 16 A	CEE 32 A	CEE 32 A	CEE 32 A
Electrical connection	V / Hz	230 / 50	400 / 50	400 / 50	400 / 50	400 / 50
Room thermostat integrated		+	+	+	+	+
2-stage heating			+	+	+	+
Warm air hose 7,6 m Ø 305 mm	€ No.					280,- 005417
Warm air hose 3 m Ø 305 mm -40°C to +175°C	€ No.					398,- 045720
Combined warm air hose 7,6m Ø 305 mm consists of: 1 hose 3 m / -40°C to +175°C 1 hose 4,6 m / -20°C to +100°C	€ No.					560,- 045723
Hose connection piece Ø 305 mm for hose extension	€ No.					32,- 002873
external room thermostat for 2-stage heating automatic operation for E 18 S on request						

* with hose connection available from 09/2011

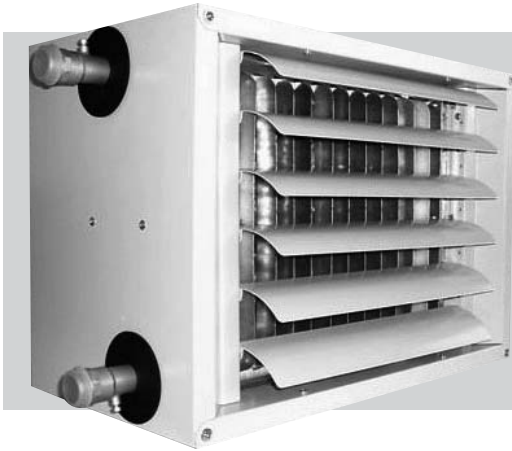

POWER RANGE 10,5 – 50 KW

- ▶ For wall and ceiling mounting
- ▶ Operation with external air, mixed air and circulated air
- ▶ For heating and ventilation
- ▶ Horizontal air outlets louvres
- ▶ Heat exchanger copper/aluminium
- ▶ Sickle-shaped fan wheel

MODEL

		LH120	LH130	LH220	LH230	LH320
Air Heater	€	594,-	612,-	632,-	673,-	894,-
Powder-coated housing	No.	038972	038973	038974	038975	038976
Power range	kW	10,5 - 13,7	13 - 17,8	16,6 - 18,1	20,5 - 24,5	20,3 - 50
Heating medium 90/70°, air 15°, BTU's in 000's	BTU	36 - 47	44 - 61	57 - 62	70 - 84	69 - 170
Air rate	m³/h	900-1.750	850-1.550	1.900-2.450	1.550-2.300	1.650-3.600
Motor	V / Hz	230/50	230/50	230/50	230/50	230/50

Special versions for steam and explosion protected on request.

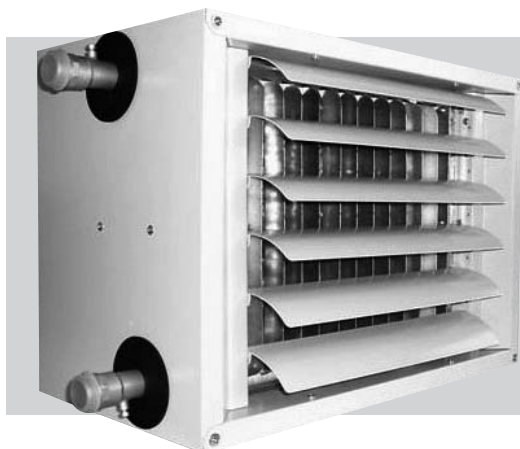

POWER RANGE 23,3 – 54 KW

- ▶ For wall and ceiling mounting
- ▶ Operation with external air, mixed air and circulated air
- ▶ For heating and ventilation
- ▶ Horizontal air outlets louvres
- ▶ Heat exchanger copper/aluminium
- ▶ Sickle-shaped fan wheel

MODEL

		LH330	LH420	LH430	LH520	LH530
Air Heater	€	976,-	1.022,-	1.064,-	1.109,-	1.158,-
Powder-coated housing	No.	038977	038978	038979	038980	038981
Power range	kW	23,3-37,4	24,1-32,7	30,3-44	29,2-40,10	36-54
Heating medium 90/70°, air 15°, BTU's in 000's	BTU	80-128	82-112	103-150	100-137	123-184
Air rate	m³/h	1.350-3.400	1.900-3.950	1.850-3.900	2.450-5.200	2.200-4.900
Motor	V / Hz	230/50	230/50	230/50	230/50	230/50

Special versions for steam and explosion protected on request.



POWER RANGE 42,1-118,4 KW





- ▶ For wall and ceiling mounting
- ▶ Operation with external air, mixed air and circulated air
- ▶ For heating and ventilation
- ▶ Horizontal air outlets louvres
- ▶ Heat exchanger copper/aluminium
- ▶ Sickle-shaped fan wheel

MODEL



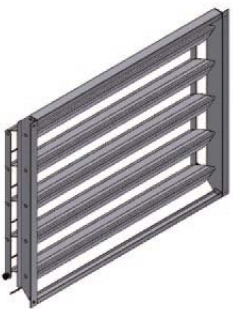

		LH620	LH630	LH720	LH730	LH920	LH930
Air Heater	€	1.265,-	1.367,-	1.386,-	1.509,-	1.559,-	1.754,-
Powder-coated housing	No.	038982	038983	038984	038985	038986	038987
Power range	kW	42,1-48,6	54,4-64,7	62,7-69,4	80,7-90,4	80,2-91,2	105,1-118,4
Heating medium 90/70°, air 15°, BTU's in 000's	BTU	144 - 166	186 - 221	214 - 237	276 - 309	274 - 311	359 - 104
Air rate	m³/h	4.550- 6.700	4.250- 6.200	6.550- 8.500	6.100- 7.700	8.950- 12.550	8.400- 10.900
Motor	V / Hz	400/50	400/50	400/50	400/50	400/50	400/50

Special versions for damp and explosion protected on request.

ACCESSORIES

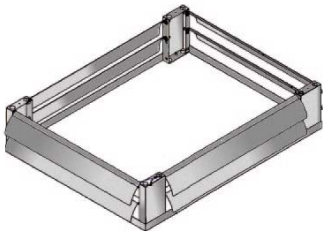
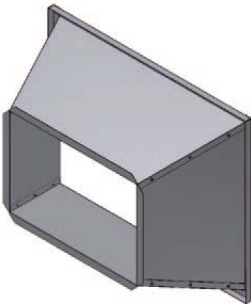



		Products	No.	€
	Console for wall installation	LH 120-130 LH 220-230 LH 320-330 LH 420-430 LH 520-530 LH 620-630 LH 720-730 LH 920-930	039024	74,-
	4 mounting brackets for ceiling mounting for powder-coated and stainless steel version	LH 120-130 LH 220-230 LH 320-330 LH 420-430 LH 520-530 LH 620-630 LH 720-730 LH 920-930	042870	45,-
	Vertical air outlet galvanised	LH 120-130 LH 220-230 LH 320-330 LH 420-430 LH 520-530 LH 620-630 LH 720-730 LH 920-930	042871 042873 042874 042875 042876 042877 042878 042879	75,- 95,- 113,- 131,- 146,- 165,- 188,- 213,-
	Vertical air outlet stainless steel	LH 120-130 LH 220-230 LH 320-330 LH 420-430 LH 520-530 LH 620-630 LH 720-730 LH 920-930	043059 043060 043061 043062 043063 043064 043065 043066	95,- 124,- 143,- 163,- 182,- 208,- 236,- 267,-
	Recirculation outlet	LH 120-130 LH 220-230 LH 320-330 LH 420-430 LH 520-530 LH 620-630 LH 720-730 LH 920-930	042880 042883 042884 042885 042886 042887 042888 042889	156,- 165,- 203,- 213,- 226,- 258,- 269,- 280,-

ACCESSORIES

		Products	No.	€
	4-sides outlet	LH 120-130	042881	149,-
		LH 220-230	042882	159,-
		LH 320-330	042890	178,-
		LH 420-430	042891	203,-
		LH 520-530	042892	226,-
		LH 620-630	042893	258,-
		LH 720-730	042894	269,-
		LH 920-930	042895	280,-
	Outlet cone	LH 120-130	042896	119,-
		LH 220-230	042897	129,-
		LH 320-330	042898	140,-
		LH 420-430	042899	151,-
		LH 520-530	042900	161,-
		LH 620-630	042901	193,-
		LH 720-730	042902	226,-
		LH 920-930	042903	258,-
	Backflash louver for rain cap and intake cap	LH 120-130	042904	95,-
		LH 220-230	042905	121,-
		LH 320-330	042906	121,-
		LH 420-430	042907	165,-
		LH 520-530	042908	165,-
		LH 620-630	042909	210,-
		LH 720-730	042910	210,-
		LH 920-930	042911	210,-
	Weather protection grill	LH 120-130	042912	92,-
		LH 220-230	042913	102,-
		LH 320-330	042914	113,-
		LH 420-430	042915	124,-
		LH 520-530	042916	134,-
		LH 620-630	042917	146,-
		LH 720-730	042918	156,-
		LH 920-930	042919	166,-
	Weather protection grill with backflash louver	LH 120-130	042920	188,-
		LH 220-230	042921	188,-
		LH 320-330	042922	264,-
		LH 420-430	042923	382,-
		LH 520-530	042924	382,-
		LH 620-630	042925	479,-
		LH 720-730	042926	479,-
		LH 920-930	042927	479,-

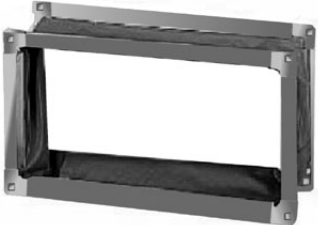
Delivered accessories may differ from picture.

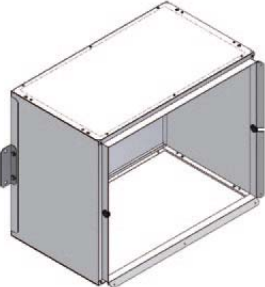
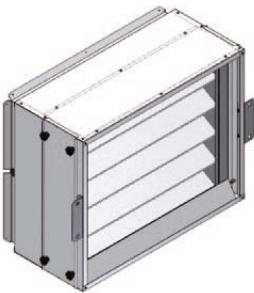
ACCESSORIES

		Products	No.	€
	Anti vibration puffer	LH 120-130	042928	49,-
		LH 220-230	042929	59,-
		LH 320-330	042930	70,-
		LH 420-430	042931	81,-
		LH 520-530	042932	92,-
		LH 620-630	042933	102,-
		LH 720-730	042934	113,-
		LH 920-930	042935	124,-
	Mixed air box	LH 120-130	042937	307,-
		LH 220-230	042938	317,-
		LH 320-330	042939	329,-
		LH 420-430	042940	339,-
		LH 520-530	042941	349,-
		LH 620-630	042942	361,-
		LH 720-730	042943	371,-
		LH 920-930	042944	382,-
	External air box	LH 120-130	042945	183,-
		LH 220-230	042946	193,-
		LH 320-330	042947	205,-
		LH 420-430	042948	220,-
		LH 520-530	042949	232,-
		LH 620-630	042950	242,-
		LH 720-730	042951	253,-
		LH 920-930	042952	263,-
	Mixing box	LH 120-130	042953	285,-
		LH 220-230	042954	296,-
		LH 320-330	042955	310,-
		LH 420-430	042956	317,-
		LH 520-530	042957	329,-
		LH 620-630	042958	339,-
		LH 720-730	042959	349,-
		LH 920-930	042960	361,-
	Intake duct	LH 120-130	042961	105,-
		LH 220-230	042962	116,-
		LH 320-330	042963	127,-
		LH 420-430	042964	137,-
		LH 520-530	042965	149,-
		LH 620-630	042966	159,-
		LH 720-730	042967	171,-
		LH 920-930	042968	181,-

Delivered accessories may differ from picture.

ACCESSORIES

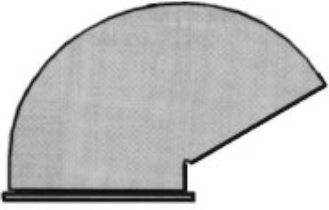
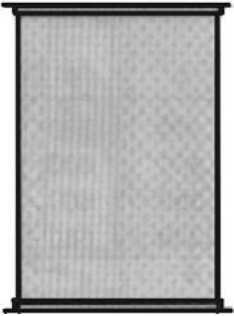
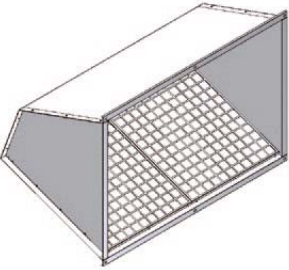
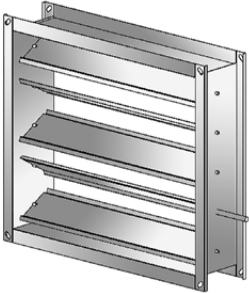
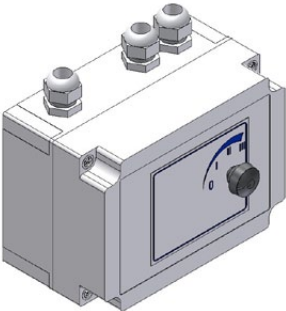
		Products	No.	€
	Rain cap	LH 120-130	042969	248,-
		LH 220-230	042970	258,-
		LH 320-330	042971	269,-
		LH 420-430	042972	280,-
		LH 520-530	042973	290,-
		LH 620-630	042974	302,-
		LH 720-730	042975	312,-
		LH 920-930	042976	320,-
	Roof grommet	LH 120-130	042977	129,-
		LH 220-230	042978	140,-
		LH 320-330	042979	151,-
		LH 420-430	042980	161,-
		LH 520-530	042981	173,-
		LH 620-630	042982	183,-
		LH 720-730	042983	193,-
		LH 920-930	042984	205,-
	Intake hood with bird protection grill	LH 120-130	043051	253,-
		LH 220-230	043052	264,-
		LH 320-330	043053	275,-
		LH 420-430	043054	285,-
		LH 520-530	043055	296,-
		LH 620-630	043056	307,-
		LH 720-730	043057	317,-
		LH 920-930	043058	329,-
	Louver flap for external air box	LH 120-130	042985	257,-
		LH 220-230	042986	320,-
		LH 320-330	042987	320,-
		LH 420-430	042988	320,-
		LH 520-530	042989	388,-
		LH 620-630	042990	536,-
		LH 720-730	042991	592,-
		LH 920-930	042992	751,-
	3-Step switch	LH 120-130	039064	205,-
		LH 220-230		
		LH 320-330		
		LH 420-430		
		LH 520-530	039065	205,-





Delivered accessories may differ from picture.

ACCESSORIES

		Products	No.	€
	5-Step switch for max. 3 Ampere	LH 120-130 LH 220-230 LH 320-330 LH 420-430 LH 520-530	040120	252,-
	5-Step switch for max. 7 Ampere	LH 120-130 LH 220-230 LH 320-330 LH 420-430 LH 520-530	040121	285,-
	1-Step switch DST 1	LH 620-630 LH 720-730 LH 920-930	022071	110,-
	2-Step switch DST 2	LH 620-630 LH 720-730 LH 920-930	022072	188,-
	5-Step switch DST 5-2	LH 620-630 LH 720-730 LH 920-930	022074	398,-



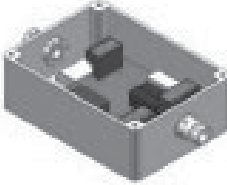

Delivered accessories may differ from picture.

ACCESSORIES

		Products	No.	€
	5-Step switch DST 5-4	LH 620-630 LH 720-730 LH 920-930	022075	482,-
	5-Step switch DST 5-6	LH 620-630 LH 720-730 LH 920-930	022076	564,-
	5-Step switch DST 5-8	LH 620-630 LH 720-730 LH 920-930	022077	754,-
	Connector IP 65 - for 2-5 air heater	LH 620-630 LH 720-730 LH 920-930	024361	183,-
	Room thermostat RT	LH 120-130 LH 220-230 LH 320-330 LH 420-430 LH 520-530 LH 620-630 LH 720-730 LH 920-930	006859	41,-

Delivered accessories may differ from picture.

ACCESSORIES

		Products	No.	€
	Room thermostat RTI, Specification IP54	LH 120-130 LH 220-230 LH 320-330 LH 420-430 LH 520-530 LH 620-630 LH 720-730 LH 920-930	005434	56,-
	Room thermostat RTIA, Specification with covered temperature control, IP54 (splash water protected)	LH 120-130 LH 220-230 LH 320-330 LH 420-430 LH 520-530 LH 620-630 LH 720-730 LH 920-930	005951	85,-
	Room thermostat RTU with analog timer	LH 120-130 LH 220-230 LH 320-330 LH 420-430 LH 520-530 LH 620-630 LH 720-730 LH 920-930	022078	180,-
	Room thermostat RTD with digital timer	LH 120-130 LH 220-230 LH 320-330 LH 420-430 LH 520-530 LH 620-630 LH 720-730 LH 920-930	022079	193,-
	Day/night automatic control with plastic box, for night mode, With digital clock, power reserve, day and week programm, 1 room sensor included	LH 120-130 LH 220-230 LH 320-330 LH 420-430 LH 520-530 LH 620-630 LH 720-730 LH 920-930	006708	384,-

Delivered accessories may differ from picture.

ATMOSPHERIC



POWER RANGE 17 – 37 KW

- ▶ Natural or liquid gas
- ▶ Electronic ignition
- ▶ Axial fan

MODEL

Single step axial fan		N2	N3	N4
€		2.036,-	2.149,-	2.300,-
No.		034242	034243	034244
Two step axial fan Two stage burner		N24	N34	N44
€		2.477,-	2.615,-	2.803,-
No.		034249	034250	034251
Rated heat load	kW	17,3	27,2	36,7
BTU's in 000's	BTU	59	93	125
Air rate max.	m³/h	1.630	2.550	3.450
Heat exchanger stainless steel		+	+	+
Natural gas		+	+	+
Liquid gas		+	+	+
Electronic ignition		+	+	+
Exhaust gas fan		+	+	+

GAS-WARM AIR HEATERS



ATMOSPHERIC



POWER RANGE 41,7 – 94,2 KW

- ▶ Natural or liquid gas
- ▶ Electronic ignition
- ▶ Axial fan

MODEL

Single step axial fan		N5	N7	N9	N11
€		3.173,-	4.087,-	5.391,-	6.303,-
No.		034432	034435	034443	034448
Two step axial fan Two stage burner		N54	N74	N94	N114
€		3.658,-	4.724,-	5.215,-	7.284,-
No.		034438	034445	034450	034452
Rated heat load	kW	41,7	58,5	76,6	94,2
BTU's in 000's	BTU	142	200	262	322
Air rate max.	m³/h	4.130	5.900	7.900	8.750
Heat exchanger stainless steel		+	+	+	+
Natural gas		+	+	+	+
Liquid gas		+	+	+	+
Electronic ignition		+	+	+	+
Exhaust gas fan		+	+	+	+

DUCT VERSION



POWER RANGE 22 – 94 KW
DUCT VERSION

- ▶ For internal installation
- ▶ Natural or liquid gas
- ▶ Electronic ignition

Unit for external installation on request.

MODEL

		NK3	NK4	NK5	NK7	NK9	NK11
Radial fan 200 Pa for internal installation	€ No.	3.405,- 034458	3.630,- 034469	4.384,- 034471	5.793,- 034474	7.563,- 034477	8.920,- 034479
Radial fan 200 Pa two stage burner for internal installation	€ No.	3.504,- 034481	3.735,- 034483	4.513,- 034485	5.964,- 034487	7.785,- 034489	9.382,- 034491
Rated heat load max.	kW	22,9	30,4	41,7	58,5	76,6	94,2
BTU's in 000's	BTU	78	1047	142	200	262	322
Air rate max.	m³/h	1.820	2.920	4.130	5.900	7.900	8.750
Stainless steel heat exchanger		+	+	+	+	+	+
Natural gas		+	+	+	+	+	+
Liquid gas		+	+	+	+	+	+
Electronic ignition		+	+	+	+	+	+
Exhaust gas fan		+	+	+	+	+	+

GAS-WARM AIR HEATERS



DUCT VERSION



POWER RANGE 22 – 94 KW
DUCT VERSION









- ▶ For internal installation
- ▶ Natural or liquid gas
- ▶ Electronic ignition

Unit for external installation on request.





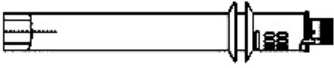
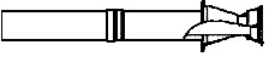

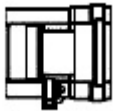
MODEL

		NK3D	NK4D	NK5D	NK7D	NK9D	NK11D
Radial fan 500 Pa for internal installation	€ No.	3.537,- 034517	3.826,- 034519	4.645,- 034521	5.124,- 034523	7.957,- 034525	9.382,- 034527
Radial fan 500 Pa two stage burner for internal installation	€ No.	3.635,- 034529	3.923,- 034531	4.776,- 034533	6.294,- 034536	8.181,- 034538	9.646,- 034540
Rated heat load max.	kW	22,9	30,4	41,7	58,5	76,6	94,2
	BTU	78	104	142	200	262	322
Air rate max.	m ³ /h	1.820	2.920	4.130	5.900	7.900	8.750
Stainless steel heat exchanger		+	+	+	+	+	+
Natural gas		+	+	+	+	+	+
Liquid gas		+	+	+	+	+	+
Electronic ignition		+	+	+	+	+	+
Exhaust gas fan		+	+	+	+	+	+

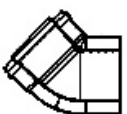

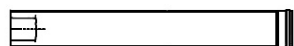
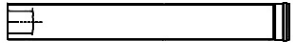
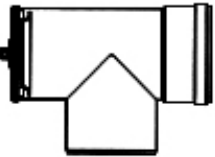

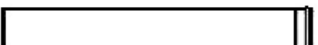
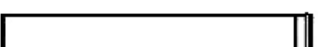
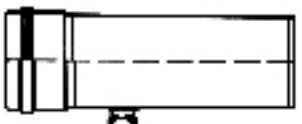

ACCESSORIES

		Products	No.	€
	Remote control with room thermostat	N 2/3/4/5/7/9/11 N 24/34/44/54/ N 74/94/114	034581	103,-
	Remote control with room thermostat and clock timer	N 2/3/4/5/7/9/11 N 24/34/44/54/ N 74/94/114	034582	252,-
	Remote programmer / thermostat with serial communication to control until 16 heaters	N 2/3/4 N 24/34/44	034583	401,-
	Main control for 4 units together with one remote control	N 5 - NK 112D	035486	396,-
	Interface card for each single step heater in connection with 034583	N 2/3/4 N 24/34/44	034584	151,-
	Interface card for each two stage heater in connection with 034583	N 2/3/4 N 24/34/44	034585	190,-
	Wall bracket	N 2/3/4/24/34/44	034605	87,-
		N 5	034606	74,-
		N 7/9/11	034607	147,-
		NK 3 - NK112D	034658	290,-
	Horizontal wall terminal Picture 30 Overall picture page 57	N 2/3/4/24/34/44	034608	94,-
		N 5/ NK3 - NK32D	034609	201,-
		N 7/9/11	034610	285,-
		NK 4 - NK112D		
	Vertical roof terminal Picture 31 Overall picture page 57	N 2/3/4/24/34/44	034640	112,-
		N 5/ NK3 - NK32D	034641	312,-
		N 7/9/11	034642	349,-
		NK 4 - NK112D		
	Exhaust gas / Fresh air pipe with end cap complete Picture 32 Overall picture page 57	N 5	034645	173,-
		N 7/9/11 NK3 - 112D	034646	191,-
	Flue pipe with measuring point and condensate drain D 80 / 125	N 2/3/4/24/34/44	034611	57,-

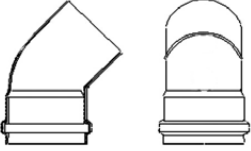
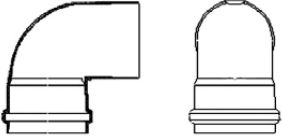
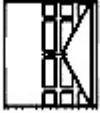
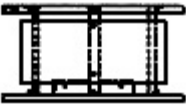
ACCESSORIES

		Products	No.	€
	Concentric bend 45° D 80 / 125	N 2/3/4 N 24/34/44	034623	44,-
	Concentric bend 90° D 80 / 125	N 2/3/4 N 24/34/44	034624	37,-
	Concentric flue pipe, L 1000, D 80-125	N 2/3/4 N 24/34/44	034643	82,-
	Concentric flue pipe, L 500, D 80-125	N 2/3/4 N 24/34/44	034644	50,-
	Concentric flue pipe, T-piece with revision opening D 80 / 125	N 2/3/4 N 24/34/44	039143	92,-
	T-piece with revision opening L 150 / D 80	N 2/3/4/24/34/44	040185	87,-
	L 150 / D 100	N 5/7/9/11	040186	70,-
	L 220 / D 150	N 7-11 / NK 7-112D	040184	110,-
	Connection piece - D 80-125	N 2/3/4 N 24/34/44	034639	28,-
	Flue pipe with gasket L 1000 D 80	N 2/3/4 N 24/34/44	034616	36,-
	D 100 exhaust gas	N 5-11 / NK 3-112D	034617	45,-
	D 150 for fresh air	N 7-11 / NK 7-112D	034613	61,-
	Picture 20/21 Overall picture page 57			
	Flue pipe with gasket L 500 D 80	N 2/3/4 N 5-11 / NK 3-112D	034618	18,-
	D 100 exhaust gas	N 7-11 / NK 7-112D	034619	31,-
	D 150 for fresh air		034615	42,-
	Flue pipe with gasket L 250 with measuring point D 100 D 150	N 5-11 / NK 3-112D N 7-11 / NK 7-112D	040180 040183	29,- 47,-
	Adjustable flue gas pipe adjustable from 265-375 mm D 80 D 100	N 2/3/4 N 5 - NK 112D	040182 040181	42,- 52,-
	T-piece with condensate drain D 100 w/w Picture 25 Overall picture page 57	N 5 - NK 112D	034632	174,-

ACCESSORIES

		Products	No.	€
	Elbow 45° D 80 D 100 m/w D 150 Picture 22 / 24 Overall picture page 57	N 2/3/4/24/34/44 N 5/ NK3 - 112D NK 7 - 112D	034625 034626 034627	18,- 35,- 48,-
	Elbow 90° D 80 D 100 m/w D 100 w/w D 150 Picture 22 / 23 Overall picture page 57	N 2/3/4/24/34/44 N 5-11NK3-112D N 5-11NK3-112D NK 7-112D	034629 034630 034631 034628	20,- 44,- 51,- 59,-
	Wall terminal (exhaust pipe) D 80	N 2/3/4/24/34/44	034633	11,-
	Roof exhaust terminal D 80	N 2/3/4/24/34/44	034635	27,-
	Wall terminal (fresh air inlet) D 80 D 100 D 150 Picture 29 Overall picture page 57	N 2/3/4/24/34/44 N 5 NK3-52D N 7-11NK7-112D	034636 034637 034638	10,- 45,- 50,-
	End cap (exhaust pipe) D 100 Picture 28 Overall picture page 57	N 5-NK112D	034634	33,-
	Rain cap D 100 Picture 27 Overall picture page 57	N 5-NK112D	034621	45,-
	Flue pipe with gasket for fresh air L 140 / D 150 Picture 26 Overall picture page 57	NK 7-112D	034620	31,-
	Centering spring	N 2/3/4/24/34/44	034622	5,-

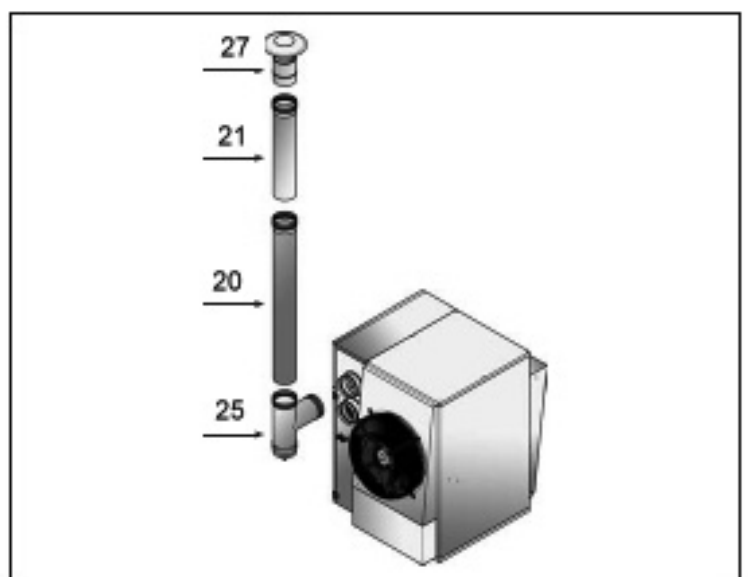
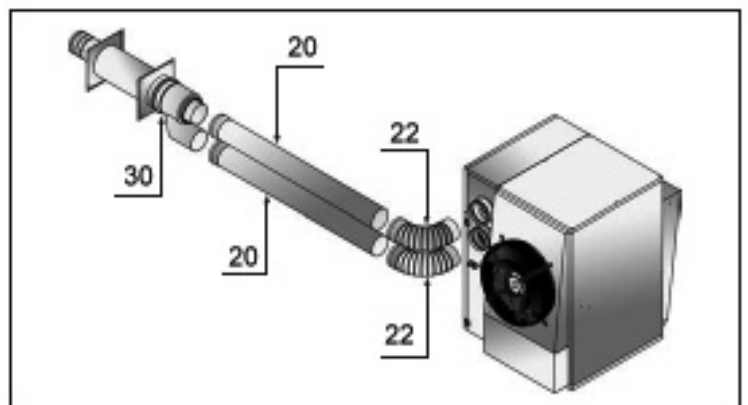
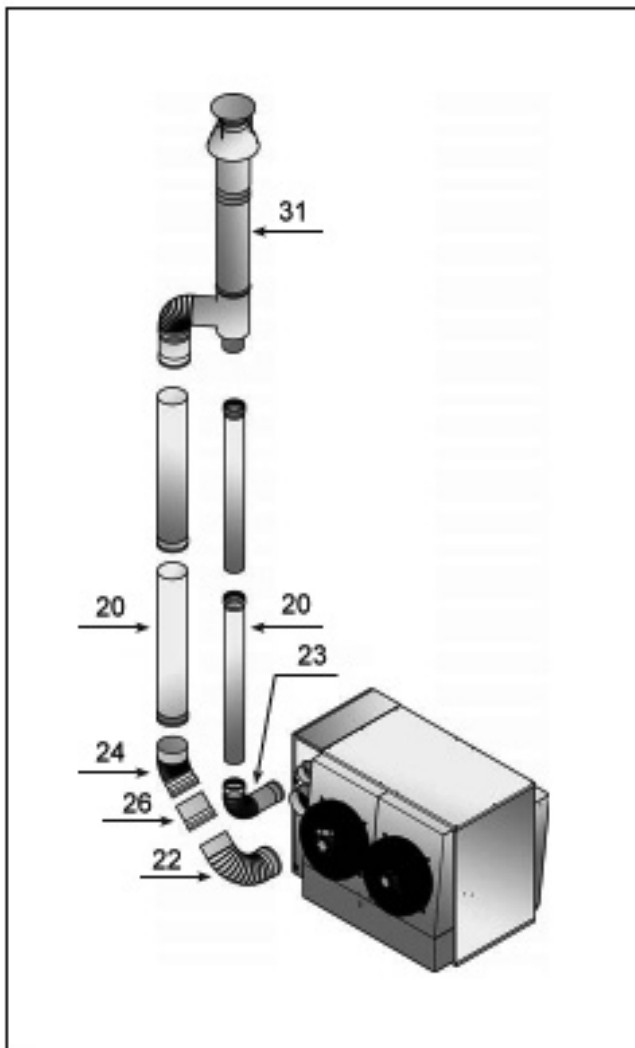
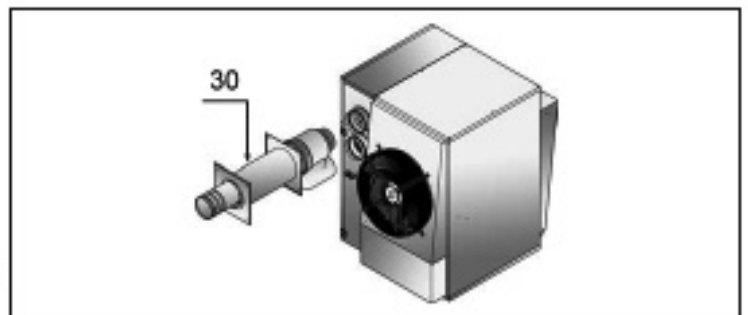
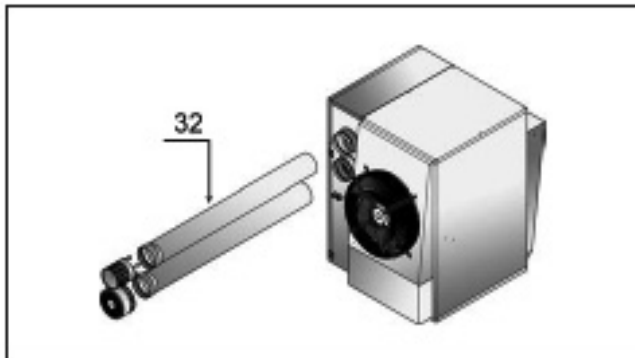
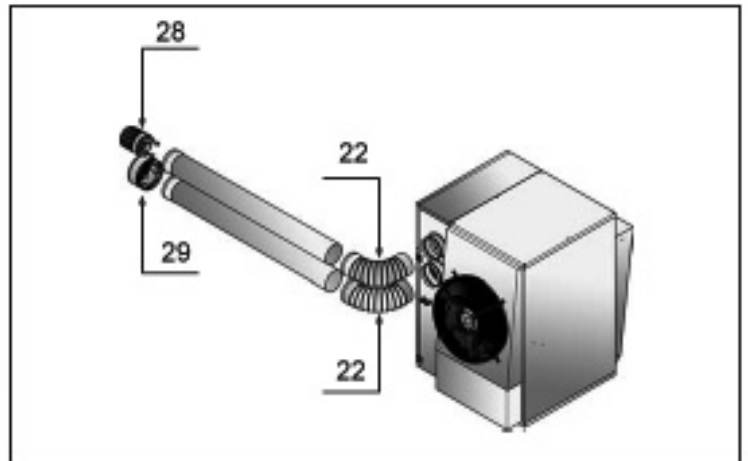
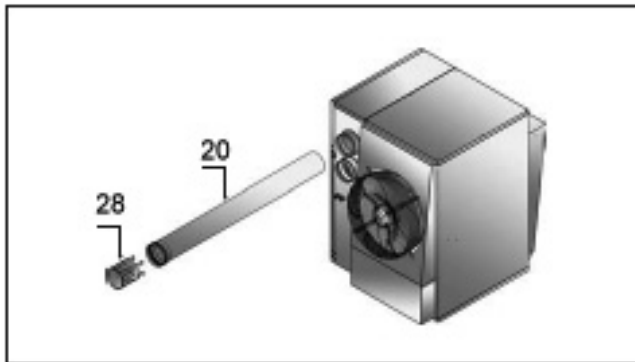



FAN

- ▶ Plastic housing
- ▶ Handle
- ▶ Stackable
- ▶ 3-stage

MODEL

SV 4000

	€	388,-
	No.	050733
Air rate	m³/h	3720
Connection	V/ Hz	230/50
Power consumption	kW	0,37



DRYING PERFORMANCE POWER RANGE 16 – 24 LITER

- ▶ Hydrostat
- ▶ Drip pan
- ▶ Plastic housing

MODEL

T16

T24

	€	411,-	522,-
	No.	028817	030060
max. water removal	l/24h	16	24
Air rate	m³/h	98	205



POWER RANGE 30 – 60 LITER

- ▶ Hydrostat
- ▶ Powder-coated steel housing
- ▶ Operating hour meter
- ▶ Hot gas unfreezing
- ▶ Drip pan
- ▶ Schuko plug

NEW

NEW

MODEL

TK 30

TK 60

	€	1.050,-	1.580,-
	No.	050653	050654
max. water removal	l/24h	30	60
Air rate	m³/h	210	900
Condensate pump	€	254,-	254,-
	No.	049046	049046



POWER RANGE 30 – 120 LITER

- ▶ Hot gas unfreezing
- ▶ Permacool long-life filter
- ▶ Operating hours meter
- ▶ Hydrostat connection
- ▶ Powder-coated housing

MODEL		T30	T40	T60	T80	T100	T120
€		1.425,-	1.806,-	2.258,-	2.626,-	2.880,-	3.450,-
No.		024447	000111	026635	038855	039238	000096
max. water removal	l/24h	30	40	60	80	100	120
Air rate	m ³ /h	280	500	750	1.100	1.100	1.500
Drip pan		+	+				

MODEL		TE40	TE60	TE80	TE100	TE120
€		1.895,-	2.309,-	2.707,-	2.960,-	3.536,-
No.		000114	033267	038856	039239	039368
max. water removal	l/24h	40	60	80	100	120
Air rate	m ³ /h	500	750	1.100	1.100	1.500
Drip pan		+				
Electric extra heating 2,0 kW		+	+	+	+	+

ACCESSORIES		T30	T40 TE40	T60 TE60	T80 TE 80	T100 TE 100	T120 TE 120
Hydrostat	€	106,-	106,-	106,-	106,-	106,-	106,-
	No.	046075	046075	046075	046075	046075	046075
Condensate pump	€	254,-	254,-	254,-	254,-	254,-	254,-
	No.	021779	021779	021779	021779	021779	021779
Overflow protection for external drip pan	€	90,-	90,-	90,-	90,-	90,-	90,-
	No.	021780	021780	021780	021780	021780	021780



- ▶ Operation in overpressure mode or vacuum mode
- ▶ Easy handling
- ▶ Controlled drying process
- ▶ Connections DN 50

MODEL

		SKV 040	SKV 075
	€ No.	1.591,- 039144	1.743,- 039145
Air rate suction and pressure	max. m³/h	90	140
Vacuum	max. mbar	-150	-140
Pressure	max. mbar	+150	+140
Weight	kg	21,5	32

ACCESSORIES

		SKV 040	SKV 075
Mains cable 5 m	€ No.	51,- 030455	51,- 030455
Inlet filter	€ No.	178,- 041024	188,- 041025
Cartridge	€ No.	61,- 034002	61,- 034002
Slot nozzle 180 mm connection 38 mm	€ No.	136,- 029240	136,- 029240
Slot nozzle 300 mm connection 38 mm	€ No.	144,- 021393	138,- 021393

WATER SEPERATOR



- ▶ Housing made of stainless steel
- ▶ Integrated socket 10 A
- ▶ Sewage water pump with level control
- ▶ Integrated coarse filter

MODEL

		WAS
	€ No.	1.686,- 032427

Conditions of Sales and Delivery (Stand 04/11)

In commercial business transactions

§1 – General Conditions

1. Our sales and delivery conditions are exclusively applicable. Statements of the Buyer contradicting to or deviating from our general business conditions will not be recognised, although they are not explicitly contradicted and/ or delivery has been effected without any reservation.
2. These sales and delivery conditions are applicable for all current and future business relations. Former, eventually otherwise expressed sales and delivery conditions lose their validity.

§2 – Conclusion of the contract

1. Our offers are subject to change.
2. Technical and constructive changes, like change in form, colour and / or weight are subject to reasonable changes.
3. Orders, amendments and changes to an order, shall be recognised only when they are confirmed by us in a written form, or the goods from the order are already delivered.
4. Costs estimations, drawings and other similar documents should be treated as private and intellectual property of our company and we reserve the rights for them.

§3 – Terms of delivery

1. Agreed delivery periods begin with the conclusion of the contract, however, not before the receipt of all documents to be given from the purchaser, including complete technical specification, authorizations, approvals or provisions, which are necessary for the execution of the contract, and not before the agreed payment is received.
2. The Seller is authorized to undertake a partial delivery, in case they are inevitable and reasonable.
3. Events of acts of nature beyond controls, as well as other unforeseen circumstances, especially malfunctions in provision, production or delivery, strike, lockout or similar, release us for the duration of the perturbation, as well as for a reasonable start-up period, – also during an already given delayed delivery period –, from our delivery obligation, as far as the perturbation has not been caused consciously or grossly negligently by us, our legal representatives, auxiliary persons or assistants. If delivery becomes, for the above mentioned reasons, impossible or economically unreasonable, we are released from our contractual obligations. Claims for damages from the purchaser are excluded.
4. Our delivery obligation stays at rest, as long as there are not only inessential purchaser's debts in arrear.

§4 – Prices and payment conditions

1. The prices confirmed by us are applicable ex works, packing excluded, plus the current obligatory value added tax.
2. Expenditures that arise from changes in the way or the amount of the delivery and on request of the buyer after our order confirmation, and/ or arising from the fulfillment of afterwards occurred, or unforeseeable authority instructions, will be also charged in addition to the quoted purchasing price.
3. In case of decisive change of price factors for working material, vendor parts, salaries, social charges, energy costs, turnover and commercial taxes or customs duties after the conclusion of the contract, we reserve the right to increase the prices stated in the order confirmation, accordingly for those goods, that are to be delivered after more than six weeks after conclusion of the contract. In case of a price increase of more than 5% on the prices stated in the order confirmation, the purchaser has the right to resign from the contract within one month after being informed of the change in price.
4. Assembly costs will be separately charged.
5. Discounts from price are to be stated in written form.
6. Unless otherwise specified, the purchasing price is to be paid without deduction within 30 days after invoice date.
7. The Buyer has the right for charging only when his / her claim is legally stated, unquestionable or acknowledged by us.
8. The Buyer has the right of retention only as far as his/ her counterclaim is based on the same contractual relation.
9. If we become aware of any circumstances, which justify legitimate doubts concerning the Buyer's creditworthiness, and if the Buyer is, in spite of respective demand, not ready to pay in advance or to provide appropriate security, we reserve the right to resign from the contract.

§5 – Transfer of perils

1. The delivery of goods is generally effected ex works.
2. Risk of coincidental loss or coincidental deterioration of goods is passed to the Buyer when the Goods are placed at the disposal of the Buyer at the Seller's premises, or, in case of consignment purchase, in the moment of transfer of the goods to the forwarding agent. When the Buyer is unable to receive the goods, the risk of coincidental loss and of coincidental deterioration of the goods is passed from the Seller to the Buyer from the day on, when the Buyer is advised of the good's readiness to be dispatched. Eventually occurring storage costs are for the account of the Buyer.

§6 – Reservation of property rights

1. We reserve the property right for our goods, until entire payment is received, also for all outstanding claims existing in the complete business relation.
2. In case the Buyer does not abide the contract, especially concerning the payment conditions, we have the right to cancel the contract and to collect back our goods. After taking back the goods, we have the right to use them. The revenue coming out of the exploitation of the goods is credited on the Buyer's payables – appropriate costs of exploitation deducted-. In case the withdrawal cannot be realised we are entitled to claim for damages.

3. The Buyer has the right to resell the goods in accordance with his / her adequate and orderly accounting business. The buyer transfers, already now, all claims against his buyers of the resold goods, to us. We herewith accept the transfer. The Buyer remains authorized to collect claims transferred to us. This authorisation expires immediately when the Buyer ceases his payments.
4. In case of garnishment, other interventions of other persons or eventual damages or destruction of the goods, the Buyer has to inform us immediately. Also a change of property of the purchased subject, as well as a change of registered office has to be indicated without delay.

§7 – Claims for defects

1. The Buyer has the right to claim defects only after his duly fulfilled obligations of inspection and reproof according to § 377 HGB.
2. In case there is evidence of defect taken by us, we will eliminate it at our option and for our account, or we will deliver goods without defects (supplementary performance). The purchaser has the obligation to allow examination of the goods – if demanded- also by third party.
3. As character of the object of purchase, only our product description is valid. Paralell public exclamation, praise or advertising does not represent any contractual indication of the character of the goods.
4. We take responsibility according to legal law, as far as the purchaser is claiming compensation, which result of intention or gross negligency. As long our behaviour can not be proved as an intentional or grossly negligent breach of duty, the responsibility of compensation is limited to the damage, arising typically in the respectiv case. This is not valid for responsibility of life, body or health, neither for the obligatory responsibility according to the law of product liability.
5. The period for claiming defected goods by the purchaser is one year from the date of delivery of the goods.
6. The purchaser is not given any guarranties in the sense of Law by us. Guarantees of producer are not concerned herewith.

§8 – Responsibility

1. Concerning other claims for damages we are responsible at best, in case of lightly negligent breach of duty, only for that kind of damage, that is typically arising for this kind of the object of purchase. This is valuable also for lightly negligent breaches of duty by our legal representatives or assistants.
2. Our responsibility for lightly negligent breaches of unessential duties is excluded.
3. Responsibility of guilty damage of life, body or health remains untouched. Also the obligatory responsibility according the law of product liability.

§9 – Place of fulfillment

The place of fulfillment for delivery is respectively the place from where the goods are sent, for payments and other liabilities reporting to the contract it is the address of the our registered office.

§10 – Final Clauses

1. The law of the Federal Republic of Germany is valid. The clauses of UN Convention on Contracts for the International Sale of Goods are not applicable.
2. As an exclusive jurisdiction for all disputes out of this contract the competence of either the Regional or the County court is agreed, dependent of the value of the object.
3. Purchaser's date necessary for the execution of the order, are safed and processed for own purpose. Notification according § 33 BDSG resulted with this.
4. Should single terms of the contrat, including these conditions of sale and delivery, are or become partially or completely void, the validity of the other terms remain thereof untouched. The completely or partially void term, shall be replaced by a term, whose economic success is as close as possible to that of the void term.

Kroll GmbH

Highly modern production lines and a constant, uncompromising quality management ensure that Kroll products are of impeccable workmanship and long durability.





Kroll GmbH
Pfarrgartenstrasse 46
D – 71737 Kirchberg / Murr
Phone: 0049 (0)7144 / 830 200
Fax: 0049 (0)7144 / 830 201
e-mail: vertrieb@kroll.de
Internet www.kroll.de
Service Hotline 0049 (0)7144 / 830 222



Price list for heating/ventilating/dehumidifying 04/11
Technical data subject to change without notice